

# ***Brandt***

INSTRUCTIONS FOR USE

## Washing machine

WTC9680



# ***Brandt***

*As part of our commitment to constantly improving our products, we reserve the right to make changes to them based on technical advances to their technical and functional features and appearance.*

***Warning :***

***Before installing and using your appliance, please carefully read this Guide to Installation and Use, which will allow you to quickly familiarise yourself with its operation.***

• **CONTENTS**

	Page		Page
Removing the transport packing	.4	Programming	.6
Moving your machine	.4	Details of the programmes and options	.7
Connecting to the cold water supply	.4	Modifying a washing programme	.8
Draining away the waste water	.4	Automatic safety systems	.8
Connecting to the electricity supply	.5	Cleaning the pump filter	.9
Installing your machine	.5	Maintaining your machine	.9
Loading your washing	.5	Incidents that may arise	.10
Loading the washing products	.5	Messages shown on the display	.10

Dear Customer,

You have just acquired a **BRANDT** washing machine and we would like to thank you.

We have invested all our dedication and know-how in this appliance so that it would best meet your needs. With innovation and performance, we designed it to be always easy to use.

In the **BRANDT** product range, you will also find a wide choice of ovens, microwaves, cooking hobs, ventilation hoods, cookers, dishwashers, driers, fridges and freezers, that you can coordinate with your new **BRANDT** washing machine.

Visit our website [www.brandt.com](http://www.brandt.com) where you will find all of our products, as well as useful and complementary information.

[www.brandt.com](http://www.brandt.com)

**BRANDT**

• **SAFETY ADVICE**

**! Important :**

**This machine is only for domestic use and is designed to wash, rinse and spin machine-washable textiles. You must observe the following instructions. We will not accept any liability and the warranty will be void if you do not observe these recommendations since this could result in damage to the appliance or cause physical injury.**

– This appliance is not intended for use by persons (including children) with reduced physical, sensory or mental capabilities, or lack of experience and knowledge, unless they have been given supervision or instruction concerning use of the appliance by a person responsible for their safety.

– The machine must only be used in accordance with its normal method of operation in order to avoid damaging your laundry and your machine. Only use washing and maintenance products certified for use in domestic washing machines.

– If you pre-treat your washing with stain removers, solvents or, in general, any inflammable or potentially highly explosive product, do not place them into the machine immediately.

Furthermore, you are also recommended not to use solvents or products in aerosol cans near to your washing machine or any electrical appliance in general in a poorly ventilated room (risk of fire and explosion).

– If any incidents occur and you cannot resolve them using the remedies we recommend (see the section “TROUBLESHOOTING”), call in a qualified technician.

– If you have to open your machine during a cycle (for example, to add or remove washing), depending on the stage the programme is at (during washing essentially), be careful of the temperature inside the machine, which may be very high (risk of severe scalds).

– When making a new installation, the machine must be connected to the water supply with a new hose: the old hose must not be re-used.

– Do not let children play with the machine and keep your pets away from it.

– You must immediately make any obsolete machine unusable. Disconnect and cut off the power cable flush with the machine. Turn off the water tap and remove the hose. Disable the door lock.

– If there is a risk of frost, disconnect the water hose and drain off any water that may remain in the drain hose by placing this as low as possible in a bowl.

• **SAVING ENERGY**

– Only programme a prewash when it is absolutely necessary: for example, for very dirty/badly shined laundry.

– A low temperature programme is sufficient for impeccable washing results when your washing is only slightly or moderately dirty.

– For washing that is only slightly dirty, select a short washing cycle .

– Use the right amount of washing products for the hardness of the water, the amount of washing and how dirty it is and follow the instructions on the detergent packs (use only low suds detergent).

• **ENVIRONMENTAL PROTECTION**

This appliance’s packaging material is recyclable. Help recycle it and protect the environment by dropping it off in the municipal receptacles provided for this purpose.

 Your appliance also contains a great amount of recyclable material. It is marked with this label to indicate that in countries that are a members of the European Union the used appliances should not be mixed with other waste.

This way, the appliance recycling organised by your manufacturer will be done under the best possible conditions, in compliance with European Directive 2002/96/EC on Waste Electrical and Electronic Equipment. Contact your town hall or your retailer for the used appliance collection points closest to your home.

We thank you doing your part to protect the environment.

• **DESCRIPTION OF YOUR MACHINE**

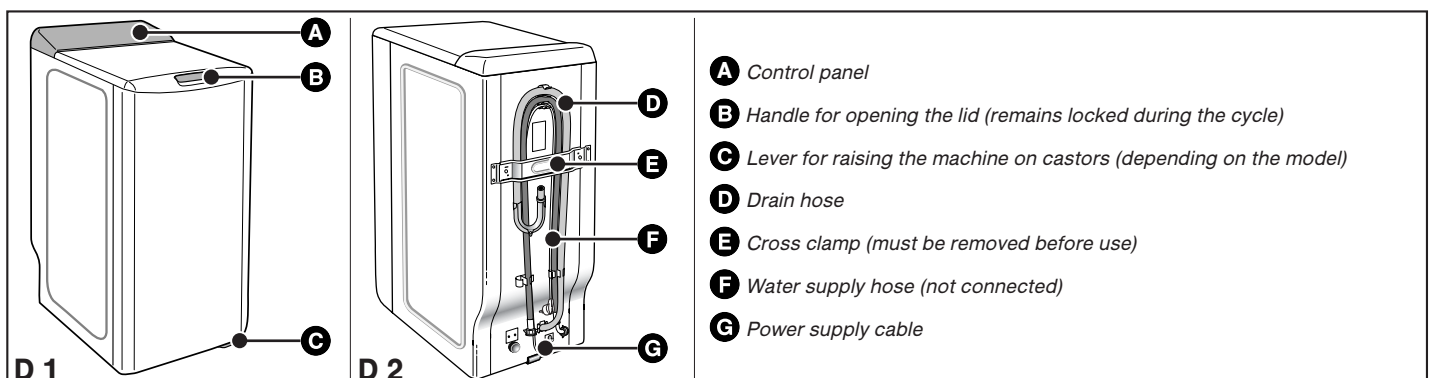

- A** Control panel
- B** Handle for opening the lid (remains locked during the cycle)
- C** Lever for raising the machine on castors (depending on the model)
- D** Drain hose
- E** Cross clamp (must be removed before use)
- F** Water supply hose (not connected)
- G** Power supply cable

• REMOVING THE TRANSPORT CLAMPS

**⚠ Important:**  
Before using the machine in any way, you must first perform the following operations.

These comprise removing all the components designed to immobilise the drum in your machine during transport.

These so-called “releasing” operations are necessary for your machine to operate correctly and to conform to the prevailing safety standards. If they are not carried out completely, this could cause severe damage to your machine while it is operating.

– Remove the washing machine from its plinth (check that the wedge **A** supporting the motor is not still inserted in the machine) (Diagram D3)

– Remove the 4 screws **B** with a screwdriver (Diagram D4)

– Remove the cross clamp **C** by removing the 2 screws **D** (Diagram D5) using a 10 or 13mm spanner (depending on the model). (Ensure that you remove the two plastic braces fixed on the cross clamp at the same time as the clamp itself).

– Replace the screws **B** in their initial positions.

**⚡ Warning:**  
You must block off the two holes using the hole covers provided **E** (supplied in the accessories bag) (Diagram D6)

– Remove the drum-tank assembly locking wedge (Diagram D7).

To do this:

- Lift the lid on the machine
- Remove wedge **F**
- Remove wedge **G**.

**⚡ Warning:**  
Remove the pipe support collars **H** You must block off the holes revealed with the hole covers **I** supplied in the accessories bag (Diagram D8).

**🗨 Advice:**  
We would recommend that you keep all the locking components since these must be refitted if you must subsequently transport your machine again.

**🗨 Information:**  
Your machine has been scrupulously checked before it left the factory. You may therefore notice a little water still remaining in the tank or the products box.

• MOVING YOUR MACHINE

• Mounting it on castors

If your machine is equipped with removable castors, you will be able to move it quite easily.

To mount it on castors, swivel the lever on the bottom of the machine from the right to the far left (Diagram D9).

**⚠ Important:**  
The machine must not rest on the “front” castors while it is operating: remember to return the lever to its initial position.

• CONNECTING TO THE COLD WATER SUPPLY

Connect the supply hose (Diagram D10):

– At one end to the connection on the back of the machine

– On the other end to a tap fitted with a threaded end 20mm dia. x 27 (3/4 BSP).

If you use a self-piercing tap, the useful aperture must have a minimum diameter of 6mm.

Water supply:

- Minimum water pressure: 0.1 MPa or 1 bar

- Maximum water pressure: 1 MPa or 10 bars

• Replacing a water supply hose

When replacing the hose, ensure that the hose is tightly fastened and that there is a seal at both ends.

• DRAINING AWAY THE WASTE WATER

Fit the hose bracket provided inside your machine to the end of the drain hose and then connect the hose (Diagram D11):

– Either, temporarily, over a sink or a bathtub.

– Or permanently to a ventilated U-bend.

If your installation does not have a ventilated U-bend, check that the connection is not sealed. In fact, to avoid any waste water flowing back into the machine, you are strongly recommended to leave an air gap between the machine’s drain hose and the drainpipe.

In any case, the drain hose bracket must be placed at a height of 65 to 90cm higher than the base of the machine.

**⚠ Important:**  
Ensure that the drain hose is tied firmly in place with cord to avoid the bracket coming loose during draining and causing a flood. For correct draining of the waste water, make sure that the drain hose is as straight as possible. In fact, the more bends the less effective the drain pump.

The waste water can be drained away to the ground provided that the drain hose passes through a point 65 to 90cm higher than the base of the machine (Diagram D12).

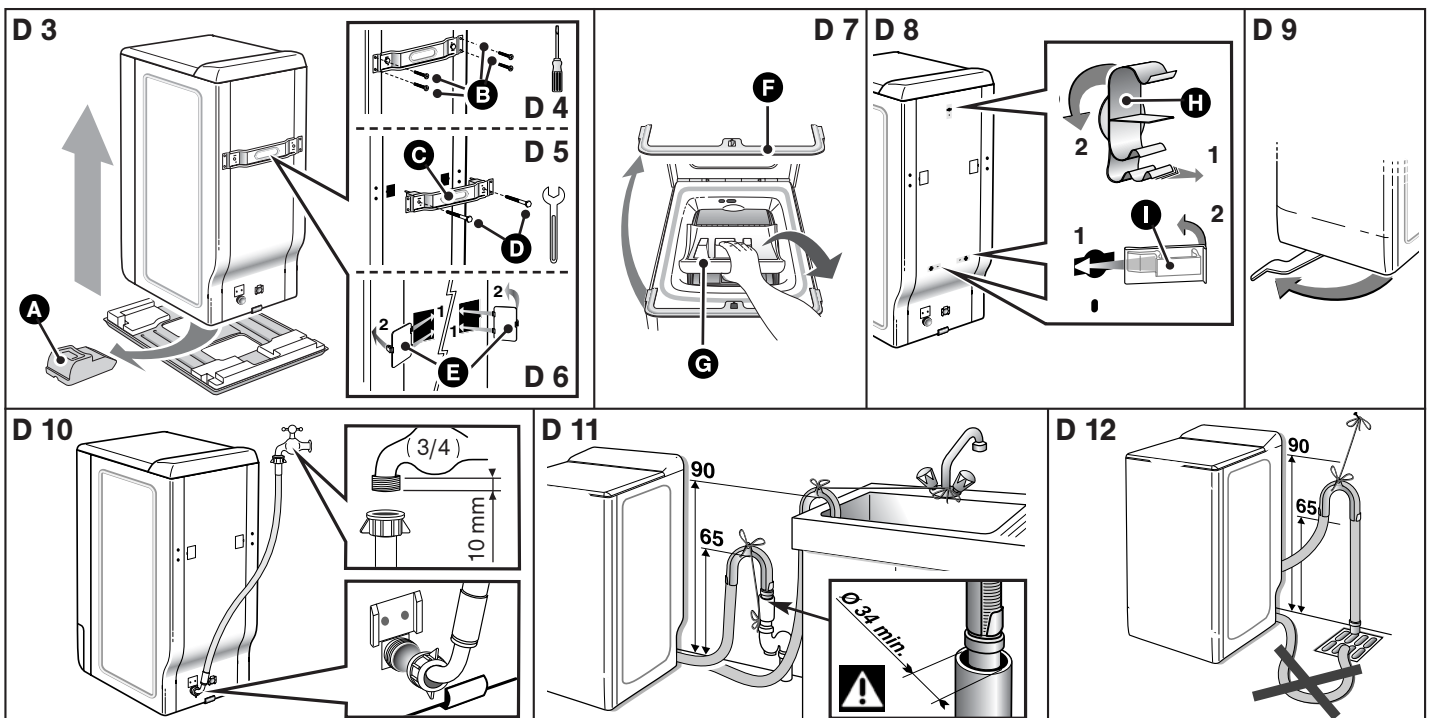

• **CONNECTING TO THE ELECTRICITY SUPPLY**

**Important:**  
For your safety, you must comply with the instructions below.

– Before connecting your machine, you must ensure that your installation's electrical characteristics match those of your machine (see the details provided on the information plate affixed to the back of the machine).

The electrical installation must comply with the prevailing standards and the Electricity Board's regulations in the country concerned, **particularly as regards Earthing** and installation in shower rooms.

**We cannot be held responsible for any incident caused by the machine being incorrectly earthed.**

**Advice:**  
Advice on the electrical installation of your machine

- Do not use an extension lead, adapter or multiple socket.
  - **Never** cut out the Earth wire.
  - The socket must be readily accessible but out of the reach of children.
- If in any doubt, please contact your installer.**

**Important:**  
Your machine conforms to European Directives 2006/95/CE (Low Voltage Directive) and 2004/108/CE (Electromagnetic Compatibility).

• **INSTALLING YOUR MACHINE**

**Important:**  
If you are installing your machine next to another machine or a unit, we recommend that you leave a gap between them to allow for air circulation.

**Advice:**  
We also strongly recommend that you do NOT:

- Install your machine in a damp, poorly ventilated room.
  - Install your machine in an area where it could be subject to water splashes or humidity.
  - Install your machine on a carpeted floor.
- If you cannot avoid doing this, please take every precaution to avoid blocking air circulation at the bottom of the machine in order to ensure that the internal components are well ventilated.

• **Levelling the machine**

Use a spirit level to check that the floor is horizontal: maximum slope 2°, i.e. a discrepancy of approximately 1cm over the width and of 1.5cm over the depth of the machine.

• **Adjustable feet**

Some machines are fitted with two adjustable feet at the front to enable you to compensate for any unevenness in the floor. Proceed as follows to adjust the feet to level and stabilize your machine:

- Set the machine on its castors (or tilt it slightly backwards if it does not have retractable castors)
- Screw in or unscrew the feet to adjust the height to suit the shape of the floor (Diagram D13)
- Set the machine back on its feet and check that it is stable.

• **TEXTILE MAINTENANCE CODES**

– **Washing** : Never exceed the indicated temperatures

– **Use of cold diluted bleach possible:**

– **Iron:** Low Medium High

– **Dry clean:** mineral spirit perchlorethylene all solvents

– **NB: A crossed-out code indicates that it is forbidden**

• **LOADING YOUR WASHING**

Perform these actions in the following order:

• **Open the machine**

- Check that the Programme selector is correctly positioned on "OFF".
- Depending on the model, lift the opening handle or press the push button on the front of the machine.

The lid will open.

- Open the drum by pressing the button on the front door.

• **Insert your washing**

For optimum washing performance, place your washing, preferably sorted and loosely, in the drum, distributing it evenly without heaping it up. Mix large and small items to obtain an optimum, well-balanced spin.

• **Close the drum**

Ensure that the drum is correctly closed.

**Important:**  
Check that the three hooks and the border of the button are fully visible.

• **LOADING THE WASHING PRODUCTS**

**Important:**  
(Diagram D14)

– The "WASH" container may contain powder or liquid but liquid detergent should not be used for programmes WITH Prewash and/or WITH "Delayed Start" (depending on the model).

– Concentrated softener should be diluted with warm water.

– To fill the product containers correctly, place the lid fully open.

– Do not exceed the **MAX** level.

• **Dispensing the detergent**

The amount of detergent to be used depends on the hardness of the water, the extent to which your washing is soiled and the amount of washing to be washed.

Please refer to the dosing instructions on your pack of detergent.

Warning: in most cases, the detergent manufacturer's recommendations apply to the drum filled to the maximum. Adjust the dosage correctly to the weight of the washing you have placed in the machine.

These recommendations will help you to avoid using too much detergent, which causes foam to be produced. Too much foam can reduce your machine's performance and increase the length of the washing cycle and the consumption of water.

Reminder : Use only low suds detergent when in doubt, contact your retailer or distributor.

• **Detergents for woollens and delicate fabrics**

You are recommended to use an appropriate detergent for washing these fabrics (avoid placing such detergents directly on the drum because they have an aggressive action on the metal).

• **Before your first wash**

Before making your first wash, we recommend that you carry out a "COTTON 90 wash without pre-wash" and with no washing in the drum, using a 1/2 measure of your usual detergent in order to eliminate any residues from manufacturing that may remain in your machine.

• **STANDARD COMPARISON TESTING PROGRAMME**

Cotton 60°C - 6 kg - no options - max spin.

To comply with the statement on the label, the tests are conducted in accordance with European Directive 95/12/EEC.

**D 13**

**D 14**

① | Pre-wash container (powder)

② || Wash container (powder or liquid)

③ Softener

: POWDERED DETERGENT      : LIQUID DETERGENT



• PROGRAMMING

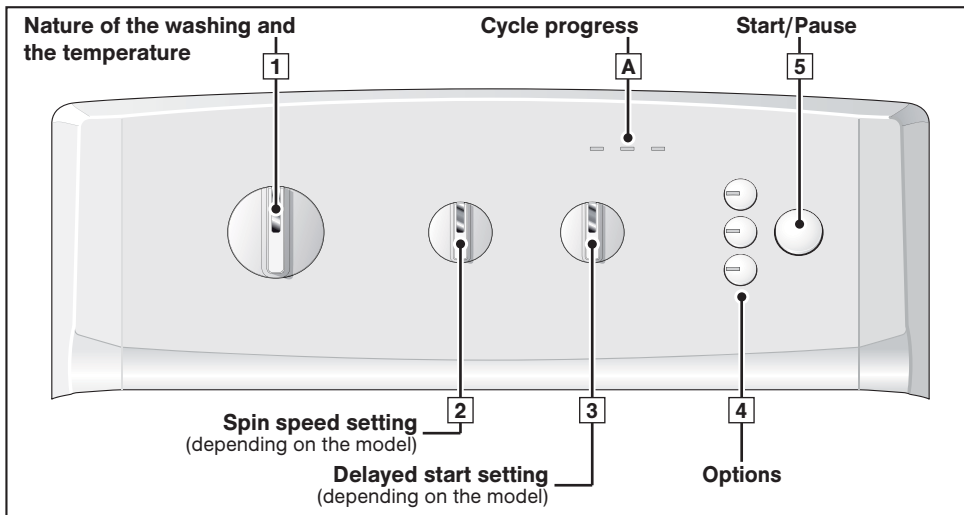

**Information:** All the buttons are on micro-switches and do not remain depressed. In any case, the "Start/Pause" button cannot cancel a programme.

**Important :** Before starting your machine, check that the power cable is plugged in and the water tap is open. Also ensure that the drum doors are closed correctly and the machine's lid is shut. During the "End of Cycle" phase, any action on one of the controls (the selectors or the buttons) returns you to "Programming" mode. As a safety measure, when the cycle is over, we recommend that you unplug the power cable and turn off the water tap.

• Programming a washing cycle:

<p>– Turn the selector <b>1</b> to choose the most suitable programme and washing temperature for the type of fabric to be washed.</p> <p><b>NB:</b> Turning the selector to any position other than "OFF" provides power to the machine.</p> <p>– Your washing machine normally spins at 800 rpm in the "Cotton", "Mixed &amp; Synthetics" and "Wool/Delicates 30°" programmes and at 500 rpm in the "Handwash" (🧴) programme. If the type of laundry requires it, however, you can reduce the spin speed to 400 rpm in all the programmes by holding down the "🌀 400 rpm" button <b>4</b>.</p> <p>– Use the other buttons <b>4</b> to select:</p> <ul style="list-style-type: none"> <li>- The "Prewash" option <b>U</b>.</li> <li>- And/or the "Drip dry" option <b>☞</b>.</li> </ul> <p>The cycle will finish with a gentle spin at 100 rpm.</p> <p>– Select immediate start by pressing "Start/Pause" <b>5</b> ...</p> <p>– ... Or use the selector <b>3</b> (depending on the model) to select starting delayed by 1 to 19 hours and then press "Start/Pause" <b>5</b>.</p>	<p>Indicator lights and position of the selectors</p> <p>"Wash" <b>U</b> light flashing (If you have selected rinse only or spin only, it is the "Rinse/Spin" light <b>🌀</b> that flashes)</p> <p>the "🌀 400 rpm" button light is lit</p> <p>Light(s) for the option(s) selected</p> <p>"Wash" <b>U</b> light permanently lit (The lights <b>A</b> illuminate in succession to show which phase the cycle is at)</p> <p>The lights <b>A</b> flash in succession until the cycle effectively starts</p>
---	--

• Adding or removing an item during the cycle (impossible during spin):

<p>– Press the "Start/Pause" button <b>5</b> to interrupt the cycle.</p> <p>– Add or remove the items of laundry.</p> <p><i>The time the lid remains locked depends on the temperature inside the machine and, for safety reasons, may take several minutes if you are interrupting a cycle at more than 40 °C.</i></p> <p>– Press the "Start/Pause" button <b>5</b> to restart the cycle.</p> <p><b>NB:</b> If you have selected a delayed start, you can access the drum instantly at any time in the period before the washing cycle starts without having to interrupt and restart the cycle.</p>	<p>Light <b>A</b> flashing</p> <p>Light <b>A</b> permanently lit</p>
---	--

• Cancelling while programming, washing or during a pause:

<p>– Set the selector <b>1</b> to the "OFF" position.</p> <p>This can be done at any time during the cycle or during programming, or even during a pause.</p> <p><b>NB :</b></p> <ul style="list-style-type: none"> <li>- In all cases, after cancelling you must reprogramme everything from the start.</li> <li>- If you have cancelled during the washing phase, remember to empty the water, if necessary.</li> </ul>	<p>Selector <b>1</b> set to "OFF"</p> <p>All the lights unlit</p>
---	---

• End of the cycle:

<p><b>NB:</b> After spinning, some models automatically position the drum opening at the top to provide easy access to the washing. This operation lasts at most 3 minutes.</p> <p>– Then, the "Stop" light comes on permanently, indicating that the cycle is over.</p> <p>Set the selector <b>1</b> to the "OFF" position.</p> <p>You can now open the lid and remove your washing.</p>	<p>The "Stop" light is permanently lit</p>
---	--

For more details on the various functions, please refer to the sections "DETAILS OF THE PROGRAMMES" and "DETAILS OF THE OPTIONS".

**Information :** After a power failure, when the power is restored, the washing cycle automatically resumes at the point where it was interrupted.













### • Maintaining your machine's performance (Maintaining the pump filter):

You must clean the drain pump filter regularly (for how to do this, see the section "CLEANING THE PUMP FILTER").

**Important :**  
Your machine's performance can be affected if you do not clean the pump filter regularly.

### • SOME EXAMPLES OF PROGRAMMES

To select the most suitable programme for your type of washing, follow the instructions on the labels that most textiles bear.

Programmes table									
Type of textile		Temperature (°C)	Maximum weight of dry clothes (kg)	Cycle length ** h = hour min = minute	Prewash	400 rpm	Rinse plus *	Drip-dry	Rinse hold *
	COTTON / WHITES	90°- 	6.0	2 h 03 - 2 h 20	●	●	●	●	●
	MIXED / SYNTHETICS	60°- 	3	1 h 19 - 1 h 40	●	●	●	●	●
	WOOL / DELICATES	30°- 	1.5	28 min - 33 min		●	●	●	●
<b>Special programmes</b>									
	Flash 30'	40°	2.5	30 min		●		●	●
	OptiA 45min	40°	6	45 min		●	●	●	●
<b>Additional programmes</b>									
	RINSE		-	17 min		●		●	●
	SPIN only		-	8 min		●		●	

● : These functions can be used alone or in combinations: **no illogical combinations can be made.**

(1) : Short 40°C cotton programme for testing institutes.

\* : Options depending on the model

### Important :

\*\* The cycle times are provided for an average value "without options". They may vary according to the wash load, the temperature, etc.

– If you programme a "Prewash", you must add 18 to 25 minutes.

– If you programme "Rinse plus", you must add 17 minutes.

### • DETAILS OF THE PROGRAMMES

The main programmes provided by the machine are as follows:

#### • Cotton / Whites

If your washing comprises hard-wearing white or coloured COTTONS.

#### Important :

**When washing coloureds do not exceed a maximum temperature of 60°C.**

**NB :** During the first few minutes of the programme, your machine automatically evaluates the washing load you have introduced and adapts the water consumption and the length of the programme accordingly to provide a perfect wash.

#### • Mixed / Synthetics

If your washing comprises of DELICATE COLOURS, HARD-WEARING SYNTHETICS or MIXED FIBRES

#### • Delicates/Wool

If your washing comprises NETTING, DELICATE FABRICS, FRAGILE TEXTILES or "MACHINE-WASHABLE WOOLLENS".

**NB :** A programme with agitation and spin phases specially adapted to these types of fabrics.

This programme is also suitable for washing textiles specified as 'hand wash' only. For this, select position .

#### • Flash 30'

This programme enables you to refresh a small load of 2.5 kg of lightly soiled washing composed of WHITES, COTTONS, COLOURED or HARD-WEARING SYNTHETICS.

The cycle time is restricted to around 30 minutes

In this programme, the washing temperature is automatically programmed at 40°C.

#### Important:

**For this programme, the doses of detergent should be reduced by half.**

#### • OptiA 45min

This 40°C programme enables you to wash a usual load of cottons and mixed textiles in 45 minutes while ensuring perfect washing results and maximum energy savings.

#### • Rinsing

A separate rinse followed by a choice of:

- Either spin and drain
- Or drain only ("Drip-dry" option)
- Or a stop with the drum full of water.

#### • Spinning

This allows a separate spin and drain.

#### Important:

**In the case of "Rinse only" followed by a spin or "Spin only", ensure that you select a suitable spin speed for the type of washing in the machine.**

## • DETAILS OF THE OPTIONS

### • Prewash

Specially designed for heavily soiled washing (mud, blood, etc.).

A specific initial agitation in cold water precedes a phase of heating to 30°C.

This agitation phase in cold water enables the particles soiling the washing to be removed before the water is heated.

**Important :**  
Detergent must be placed in the "I" container in the products box.

### • Drip Dry (spin speed "100" or button , depending on the model)



This function, for very delicate linen, enables you to remove spinning and to pass directly to the draining of the washing machine.

### • Rinse plus (depending on the model)

"Especially for sensitive and allergic skin": adds an extra rinse to the washing cycle.



### • Delayed start (depending on the model)

You can delay the start of your programme by 1, 3, 6, 9, 12, 15 or 19 hours so that you can benefit from cheap rate electricity or to have the cycle finish at a desired time.

To do this, use the selector  to choose the time you want the cycle to start and press "Start/Pause" .

#### NB:

- Even if you forget to press the "Start/Pause" button  after selecting this option, your choice will still be accepted after a few seconds.

- The three cycle progress lights (Wash , Rinse/Spin  and "Stop") flash in succession from left to right during the whole of the waiting period before the cycle effectively starts.

### • Full drum stop (Rinse hold) (depending on the model)

This function enables you to remove the washing from your machine before the spin phase or to delay this phase with you washing remaining in water to prevent creasing.

**NB :** When the machine is stopped with the tub full of water, the "Rinse/Spin"  cycle progress light flashes.

There are then two possible cases, depending on the type of machine:

#### – "Full drum stop" selected via a rotary selector:

- If you want to drain after spinning, use the selector  to choose a suitable spin speed for your type of washing.

The programme will end automatically.

- If you just want to drain, turn the selector  to "Drip Dry" (position "100").

– "Full drum stop" selected via a button: in this case, press the  button again to end the programme.

## • MODIFYING A WASHING PROGRAMME

### • During programming:

Anything can be changed before the "Start/Pause" button  is pressed.

### • After the cycle has started:

You can change the type of textile (for example, switch from "COTTON" to "SYNTHETICS", etc.). In this case, check that the options you previously selected are still there.

You must confirm your new selection by pressing the "Start/Pause" button .

The machine may then possibly drain off some of its water.



### • Throughout the cycle:

Depending on your model, the following changes are possible without pressing the "Start/Pause" button .

– You can change the temperature for the same type of textile.

**NB:** If the temperature achieved by the washing cycle is higher than your new selection, heating the water stops immediately and the cycle continues.

– You can alter the spin speed  throughout the cycle.

– You can select "Drip Dry" (100 or button ) and "Full drum stop"  throughout the washing phase.

– You can activate the "Rinse plus"  option until rinsing starts (until the "Rinse/Spin" cycle progress light  illuminates).

– You can deactivate all the options throughout the cycle provided that their action has not already finished.



### • During delayed start (Only for machines fitted with this function):

– Any kind of programme modification is accepted during a delayed start's waiting period.

– You can alter the length of a delayed start ( throughout the waiting period before the cycle effectively starts.

#### NB :

- During this period, selecting a new time cancels out the previous selection. The new period selected is accepted based on the last selection made.

- If you want to cancel the delayed start completely during this period, set the selector  to the "OFF" position and then briefly press the "Start/Pause" button .

– You can only activate the "Prewash"  option during a delayed start's waiting period.

### • When the cycle is over:

When the "Stop" light is permanently lit, you can programme a new cycle without having to reset the selector  to the "OFF" position.

For this, all you have to do is turn one of the selectors or press one of the buttons.

The "Wash"  light starts to flash.

The machine is then ready to be reprogrammed.

## • AUTOMATIC SAFETY SYSTEMS

### • Lid opening safety system:

As soon as washing commences, the lid on your machine is locked.

When the cycle is finished or when the machine has stopped with the drum full of water, the lid unlocks.

If you have programmed a "Delayed start", the lid is not locked until the waiting period is over and the cycle starts.

If you wish to open the lid during the cycle, press button  briefly and wait 1-2 minutes for the safety system to unlock the lid.

### Important :

Depending on when you wish to open the lid during the cycle, this time delay may be a little longer because a cooling down period may also have to be included.

**In fact, to avoid your being severely burnt, the lid safety system will not open during the cycle unless the temperature inside the machine is below a certain threshold.**

### • Water safety system:

During operation, constant control of the water prevents any overflows.

### • Spin safety system:

Your washing machine is fitted with a safety system that restricts the spin when poor load distribution is detected.

In this case, your washing may be insufficiently spun. Redistribute your washing in the drum and programme a new spin.

### • Anti-foam system:

Your machine can detect when too much foam is being produced during spinning.

At such times, spinning stops and the machine drains.

The cycle then restarts, adapting the spin rates and possibly adding an extra rinse.



• **CLEANING THE PUMP FILTER (Option 1)**

The way to access your pump filter may differ according to the model of the machine (see options 1 and 2).

This filter collects the small objects you may have inadvertently left in your clothes and prevents them from disrupting the pump's operation. To clean the filter, proceed as follows:

- Open the drum doors. At the back of the drum, you will see a plastic component **A** (Diagram D15)
- Release this (Diagram D16).

To do this:

- Insert a rod (a pencil or a screwdriver, for example) into the hole in the component **A**
- Press down vertically with the rod, while pushing the component **A** over to the right until it is released from its housing
- Remove the component **A**
- Turn the drum slightly towards the front of the machine, with the doors open (Diagram D17)

You can access the pump filter **B** through the openings freed by removing the plastic component **A**.

- Remove the filter from its housing (Diagram D17)
- Remove the various objects it may have in it
- Rinse it under the tap (Diagram D18)
- Re-insert it, pushing it firmly into its housing after checking that the housing is clean
- Re-insert the plastic component **A**, ensuring that it is positioned correctly in the openings at the bottom of the drum and pushing it to the left until it is fully engaged (Diagram D19).

• **CLEANING THE PUMP FILTER (Option 2)**

if your machine does not have the component **A** shown in Diagram D16, you must proceed as follows to clean your pump filter:

- Turn the drum to position the closed doors facing downwards: this will reveal a plastic component **C** (Diagram D20)
- If your machine is fitted with one, remove the screw **D**
- On certain types of machines, the component has a clip.

In this case, release the component **C** by pressing on this clip **E** while sliding the component **C** gently to the right

- Then, in all cases, turn the drum again, open the doors and remove the component **C** by sliding it in the direction of the arrow (Diagram D21)

- Turn the drum slightly towards the front of the machine, with the doors open (Diagram D22).

You can access the pump filter **F** through the openings freed by removing the plastic component **C**.

- Remove the filter from its housing (Diagram D22)
- Remove the various objects it may have in it
- Rinse it under the tap (Diagram D23)
- Re-insert it, pushing it firmly into its housing after checking that the housing is clean
- Re-insert the plastic component **C** and the screw **D** by performing all the above operations in reverse order.

• **CLEANING THE MACHINE**



**Important :**

To clean the casing, the control panel and all the plastic parts in general, use a sponge or a soft cloth dampened only with water and liquid soap.

In all cases, do not use:

- Abrasive powders
- Metal or plastic sponges
- Alcohol-based products (alcohol, thinners, etc.)

• **CARE OF THE INTERNAL COMPONENTS**

To ensure better hygiene, we recommend that you:

- Leave the lid open for a short time after washing.
- Clean the plastic and rubber access components to the tank approximately once a month using a slightly chlorinated product. Run a rinsing cycle to remove any residue of this product.
- Run a washing cycle at 90°C at least once a month.

• **CLEANING THE PRODUCTS' BOX**

Clean the products' box regularly.

To do this:

- Press the bosses **G** on each side of the box simultaneously to extract it from its housing (Diagram D24).
- Remove the siphon **H** from the rear of the box **I** and separate the box from its front cover **J** (Diagram D25)
- Rinse everything under the tap (taking care to empty any excess water remaining inside the box).
- Refit all the box' components, ensuring that the box section itself is properly clipped into the cover and then re-insert the complete assembly into its location under the machine's lid.

• **PERIODIC CHECKS**

To avoid any water damage, we recommend that you regularly check the condition of the water and drain hoses. If you notice the slightest cracking, do not hesitate to replace the hoses with identical ones available from the manufacturer or his After-Sales Service. For how to replace the water supply hose, please refer to the section "CONNECTING TO THE COLD WATER SUPPLY"

• **REPLACING THE POWER SUPPLY CABLE**



**Warning:**

For your safety, the power cable and, depending on the model, the complete electric box and its associated cable must only be replaced by the manufacturer's After-Sales Service or a qualified electrician.

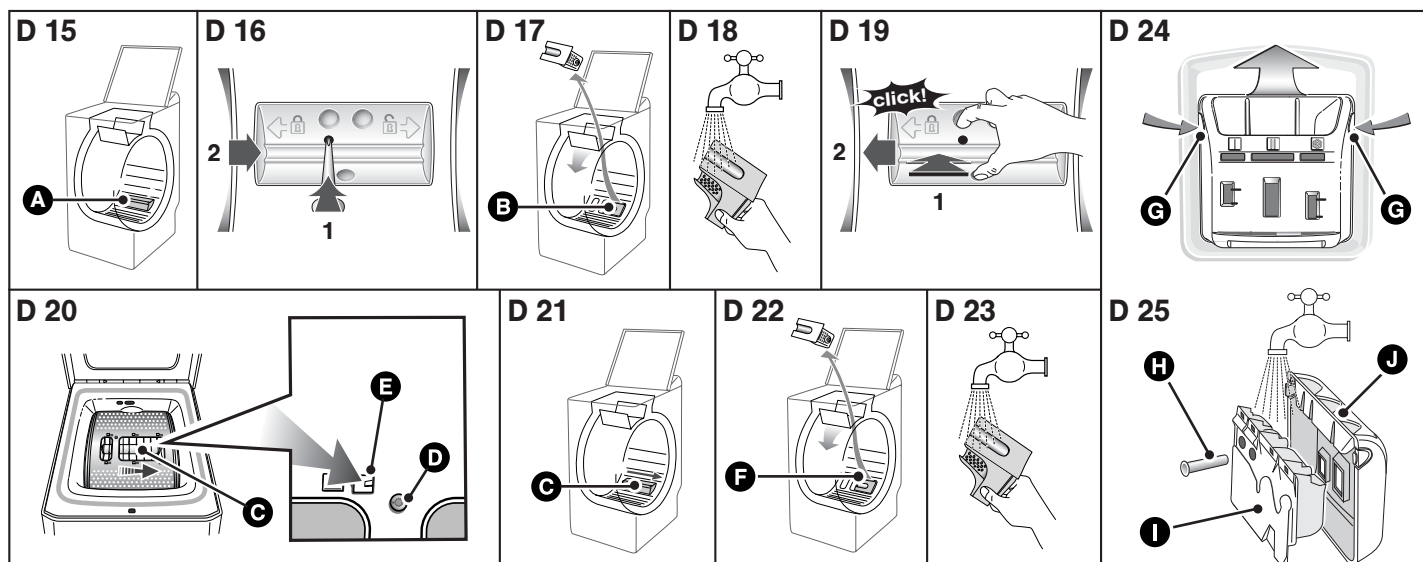

Graphic D20 is not apply to Hong Kong user.

**• INCIDENTS THAT MAY OCCUR**

**• The cycle does not start**

- You have not pressed the "Start /Pause" button
- There is no power to the machine:
  - Check that the plug is correctly in the socket
  - Check the circuit breaker and the fuses.
- The water tap is closed
- The machine's lid is not closed properly

**• A puddle of water forms around the machine**

**Warning:** *First of all remove the plug and the fuse and shut off the water supply tap.*

While the machine is operating, the permanent level control prevents the water from overflowing. If, despite this, water comes out of your machine, it may be that:

- The drain hook is wrongly positioned in the drain pipe.
- The water supply hose is not sealed tightly at the machine or tap end:
  - Check that the seals are in place and the connections are tight.

**• Heavy vibration during spin**

- All the transport materials have not been removed correctly from the machine:

- Check that all the transport wedges have been removed (see "REMOVING THE TRANSPORT CLAMPS").
- The floor is not level.
- Your machine is resting on its two "front" castors (depending on the model):
  - Reset your machine on its feet by pushing the castor engagement lever to the right.

**• The washing is not spun or not spun enough**

- You have selected a programme with no spin, for example "Drip-dry"
- The spin safety system has detected poor distribution of the washing in the drum:
  - Untangle the washing and programme a new spin.

**• The machine does not drain**

- You have programmed "Full drum stop"
- The pump filter is blocked:
  - Clean it (see "CLEANING THE PUMP FILTER" for the relevant procedure)
- The drain hose is kinked or squashed

**• The lid does not open**

- The programme has not yet finished
- The lid remains locked throughout the programme.

**• The drum doors open very slowly (On machines fitted with gently opening doors)**

- Your machine has not operated for a long time
- It is located in too cold a position.
- Detergent residue (powder) is blocking the hinges
  - In all cases, everything returns to normal after the doors have opened initially

**Important :** *As a general rule, whatever the anomaly detected, you should stop the machine, unplug the power cable and shut off the water tap*

To keep your appliance in good working order, we recommend that you use **Clearit** household products.



**Professional expertise for the general public**

**Clearit** offers you professional products and adapted solutions for the daily upkeep of your household and kitchen appliances. You may find them in conventional retail outlets, along with a complete line of by-products and consumables.

**• MESSAGES INDICATED BY THE VARIOUS LIGHTS FLASHING**

**• Incidents indicated, which you can rectify yourself**

*In this section, we explain how you can rectify these incidents very easily yourself.*

Your machine automatically detects some operating incidents and indicates these by particular options lights flashing.

Lights flashing	Causes / Remedies
	<b>The water tap is closed.</b> Check that the water tap is open and then press the "Start/Pause" button again to restart the cycle. This incident may also be caused by the drain hose being poorly connected (see the section "DRAINING AWAY THE WASTE WATER").
	<b>The pump filter is clogged.</b> Clean the pump filter (for how to do this, see the section "CLEANING THE PUMP FILTER") and then press the "Start/Pause" button again to restart the cycle. Also check the drain hose's position in the drain: the connection must not be airtight (see the section "DRAINING AWAY THE WASTE WATER").
	<b>Drain hose not positioned properly.</b> Check the drain hose's position in the drain: the connection must not be airtight (see the section "DRAINING AWAY THE WASTE WATER").
	<b>Drum blocked.</b> Check that a small item of laundry (e.g. a handkerchief or a sock, etc.) has not slipped down between the tub and the drum and is stopping the drum from turning. To access the bottom of the tub, please refer to the section "CLEANING THE PUMP FILTER".
	<b>Lid not closed properly.</b> Check that the lid is closed and then press the "Start/Pause" button again to restart the cycle.

**• Incidents indicated that require a breakdown engineer**

Your machine also detects some operating faults that systematically require the services of a breakdown engineer.



In this case, these are the three cycle progress lights that flash simultaneously.

**NB:**

*Before calling for your breakdown engineer, we would recommend that you do the following:*

- Set the Programme selector to the "OFF" position and remove the electrical plug for at least 10 seconds
  - Reconnect the plug and restart a washing cycle.
- If the fault displayed persists, call your breakdown engineer and remember to tell him which indicator lights were lit.*

**Important :** *Do not restart a washing cycle if the drum remains locked or if you notice water around your machine or if you notice a burning smell.*

**• AFTER-SALES SERVICE :**

- Possible maintenance on your washing machine should be undertaken by :
- either your dealer,
  - or another qualified mechanic who is an authorized agent for the brand appliances.
- When making an appointment, state the complete reference of your equipment (model, type and serial number). This information appears on the manufacturer's nameplate attached to the rear of the equipment.



