

Brandt



Built-in Gas Hob

Instructions for installation and use

Brandt

Content

Close-up view	1
Product specifications.....	2
Installation instructions for built-in.....	3
How to use your appliance.....	5
Practical advice.....	6
How to keep your cooking hob in shape.....	7
Is there a problem.....	7
Customer service.....	7

1. Please read this manual carefully before operating the appliance.
2. Please keep this manual for future reference.
3. Kindly keep the original invoice and warranty card for future reference for service.
4. This appliance has been designed for home use only.
5. The information contained in these instructions is essential for the correct operation of the appliance and, more importantly, for your safety. The manufacturer is exempt from all responsibility if this the requirements of this manual are not complied with.

Congratulations on choosing our appliance, which you will find dependable and easy to use. We recommend that you read this manual for best performance and to extend the life of your appliance. Thank you.

1. close-up view

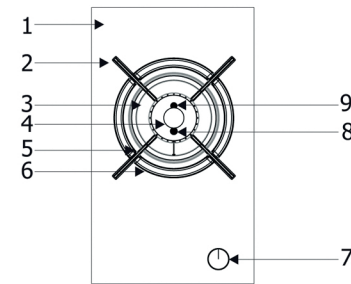

TG1431B

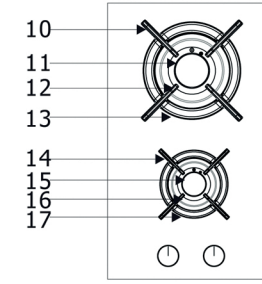

TG1432B

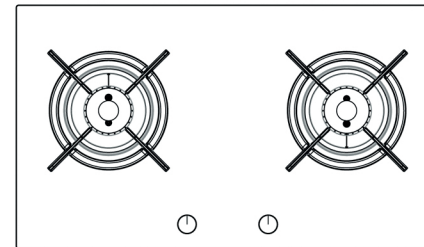

TG1482B

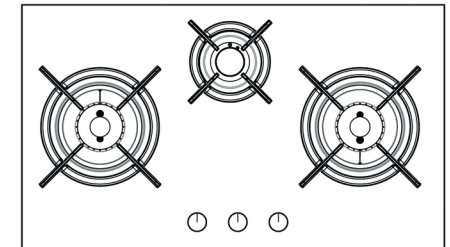

TG1483B

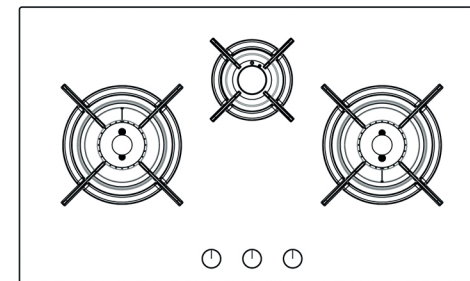

TG1493B

- | | |
|-----------------------------------|-----------------------------------|
| 1. Tempered glass top | 10. Semi-rapid burner pan support |
| 2. T burner pan support | 11. Semi-rapid burner cap |
| 3. Triple ring burner cap centre | 12. Semi-rapid burner |
| 4. Triple ring burner cap outside | 13. Semi-rapid burner water pan |
| 5. Triple ring burner | 14. Aux burner pan support |
| 6. T burner water pan | 15. Aux burner cap |
| 7. Ignition pin | 16. Aux burner |
| 8. Safety device | 17. Aux burner water pan |
| 9. Knob | |

2. Product Specifications

Model no	TG1431B		TG1432B	
Rated voltage	DC1.5V			
Product size	300×510mm			
Gas type	TG (1100pa)	LPG (2800pa)	TG (1100pa)	LPG (2800pa)
Heat input	4.5kw	4.5kw	2.5kw +1.1kw	2.5kw + 1.0kw

Model no	TG1482B		TG1483B		TG1493B	
Rated voltage	DC1.5V		DC1.5V		DC1.5V	
Product size	800×450mm		800×450mm		800×450mm	
Gas type	TG	LPG	TG	LPG	TG	LPG
Heat input	9.0kw	9.0KW	10.1KW	10.0KW	10.1KW	10.0KW

3. Installation Instructions for Built-in

The following instructions are directed at the qualified installer so that the installation and maintenance procedures may be followed in the most professional and expert manner possible.

Positioning for gas hob

Important: this unit may be installed and used only in permanently ventilated rooms

The following requirements must be observed:

A) The room must be fitted with a ventilation system which vents smoke and gases from combustion to the outside. we suggest to use Brandt family hoods.

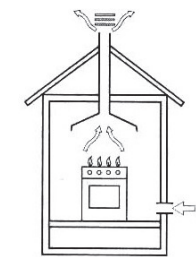

In a chimney stack or branched flue. (Exclusively for cooking appliances)

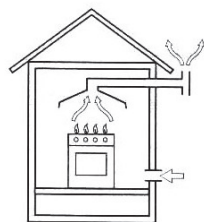

Directly to the outside

B) The room must also allow for the influx of the air needed for proper combustion. The flow of air for combustion purpose must not be less than 2m³/h per kw of installed capacity. The supply of said air can be effected by means of direct influx from the outside through a duct with a inner cross section of at least 100cm² which must not be able to accidentally blocked. otherwise, the room can be vented indirectly through adjacent rooms fitted with ventilation ducts to the outside as described above, as long as the adjacent rooms are not shared areas, bed

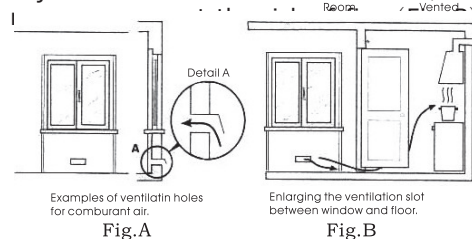

C) Intensive and prolonged use of the appliance may necessitate supplemental ventilation, e. g. opening a window or increasing the power of the air intake system (if present).

6. How to keep your cooktop in shape

Before cleaning or performing maintenance on your appliance, disconnect it from the electrical power supply.

To extend the life of the cooktop, it is absolutely indispensable for it to be cleaned carefully and thoroughly on a frequent basis, keeping in mind the following:

- The enamelled parts must be washed with warm water without using abrasive powders or corrosive substances which could ruin them;
- The removable parts of the burners should be washed frequently with water and soap, making sure to remove caked-on substances.

On cooktops with automatic ignition, the end of the ignition device must be cleaned carefully and frequently, gas holes are not clogged;

- Stainless steel can be stained if it remains in contact with highly calcareous water or aggressive detergents (containing phosphorous) for an extended period of time. It is recommended that these parts be rinsed thoroughly with water and then dried well, it is also a good idea to clean up any spills.

Clean the cooking surface when it is still warm with a suitable cleaning product. Then rub with a damp cloth and dry. Aluminum foil plastic items, objects made of synthetic material, sugar or foods with a high sugar content that have melted onto the surface must be removed immediately with a scraper while the cooking surface is still hot. Do not use abrasive sponges or cleaning products under any circumstances. Similar this holds true for chemically aggressive cleaners like oven sprays and stain removers (Fig.A)

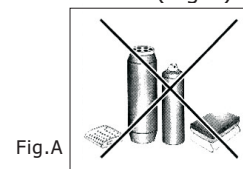

Fig.A

7. Is there a problem?

It may occur that the cooktop does not function or does not function properly. Before calling customer service for assistance, let's see what can be done. First of all, check to see that there are no interruptions in the gas and electrical supplies, and, in particular, that the gas valves for the mains are open.

The burner does not light or the flame is not uniform.

Check to make sure that:

- The gas holes on the burner are not clogged;
- All of the movable parts that make up the burner are mounted correctly;
- There are no draughts around the cooking surface.

The flame does not stay lighted on the model with the safety device.

Check to make sure that:

- You press the knob all the way in;
- All of the movable parts that make up the burner are mounted correctly;
- The gas holes are not clogged in the area corresponding to the safety device.

The burner does not remain on when set to "low".

Check to make sure that:

- The gas holes are not clogged.
- There are no draughts near the cooking surface.

The cookware is not stable.

Check to make sure that:

- The bottom of the cookware is perfectly flat.
- The cookware is centered correctly on the burner or the electric hot plate.
- The support grids have not been inverted.

8. customer service

In case of malfunction of your appliance, you may eliminate the problem by following "Is there a problem". If it persists, please contact your dealer or nearest authorized service department by telephone or mail indicating the following information:

1. Your name, telephone number and communication address;
2. The model number and serial number of your machine;
3. Description of the fault.

- Do not use the same cookware that you use for gas burners because the concentrated heat they produce can deform the bottom of the pot. Therefore, you will not achieve best results when using these pots on the electric hot plates.

5. Practical advice

To maintain the EFFICIENCY and SAFETY of this appliance, we recommend:

- Call the Service Centers authorized by the manufacturer.

- Always use original Spare Parts.

- This manual is for a built-in cooktop.

- This appliance is designed for non-professional use in the home and its features and technical characteristics must not be modified.

- these instructions are only valid for the countries the symbols for which appear on the manual and the serial plate.

- the electrical system of this appliance is safe only when it is operated under current safety standards.

Prevent children and the disabled from coming into contact or having access to the following, as they are possible sources of danger:

- The controls and the appliance in general;
- The packaging (plastic bags, polystyrene nail, etc);

- The appliance, during and immediately after use given the heat generated by its use; Surface will remain hot for at least a half hour after being turned off;

The following should be avoided:

- Touching the appliance with wet parts of the body;

- Using the appliance with bare feet;

- Pulling on the appliance or the power supply cord to disconnect them from the electrical outlet;

- Improper and/or dangerous use;

- Obstructing the ventilation or heat dissipation slots;

- Allowing the power supply cord of small appliances to come into contact with the hot parts of the cooktop;

- Exposure to atmospheric agents (rain, sun);

- Using flammable liquids nearby;
- Using unstable or deformed cookware;
- Trying to install or repair the appliance without the assistance of qualified personnel.

The assistance of qualified personnel must be called upon in the following cases:

- Installation (in accordance with the manufacture's instruction);
- When in doubt about the operation of the appliance;
- Replacement of the electrical outlet because it is incompatible with the plug.

Contact service centers authorized by the manufacturer in the following cases:

- When in doubt about the condition of the appliance after having removed the packing;
- Damage to or replacement of the power supply cord;
- In the case of a breakdown or malfunction: ask for original spare parts;

It is recommended that you follow the guidelines below:

- Only use the appliance to cook food, avoiding all other use;
- Check the condition of the appliance after it has been unpacked;
- Disconnect the appliance from the power supply in the event of malfunction and always before cleaning or maintenance;
- When not in use, disconnect the appliance from the power supply and turn off the gas valve (if present);
- Always check to make sure that the control knobs are on the "OFF" setting when the appliance not in use;
- Cut the power supply cord after disconnecting it from the electrical mains when you decide to no longer use the hob;
- The manufacturer will not be held liable for any improper, incorrect or unreasonable use.

D) Liquidified petroleum gases are heavier than air and, as a result, settle downwards. LPG tanks, whether empty or partially full, must not be installed or stored in rooms or spaces below ground level (cellars, etc.).

It is also a good idea to keep only the tank currently being used in the room, making sure that it is not near sources of heat (ovens, fireplace, stove, etc.) that could raise the internal temperature of the tank above 50°C.

Installation of built-in cook tops

The appliance can be installed next to furniture units which are no taller than the top of the cooker hob. The wall in direct contact with the back panel of the cooker must be made of non-flammable material. During operation the back panel of the cooker could reach a temperature of 50 °C above room temperature. For proper installation of the cooker, the following precautions must be taken:

a) The hob may be located in a kitchen or living room, but not in a bathroom or shower room.

b) The furniture standing next to the unit, that is higher than the working boards, must be placed at least 600mm from the edge of the board.

C) The cabinets should be positioned next to the cooktop at a height of at least 540mm (Fig. C).

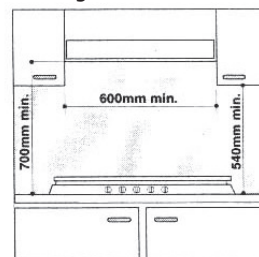

Fig. C

d) Should the hob be installed directly under a cupboard the latter should be at least 700mm from the worktop, as shown in Fig. C.

E) The dimensions of the opening for the furniture must be those indicated in the figures in the last two pages of the cover. Fixing hooks are provided which allow to place the plate on work tops that measure from 20mm to 40mm in thickness (see Fig. D).

To obtain a good fixing of the hob plate it is advisable to use all the hooks supplied.

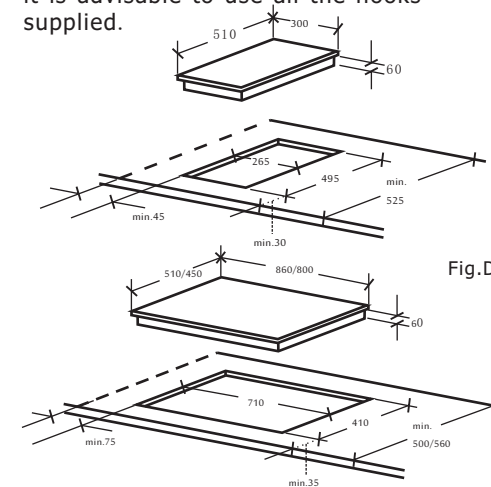

Fig.D

The hob can only be installed above a built-in oven provided with cooling ventilation

f) In the event the cooktop is not installed above built-in oven, a wood panel must be inserted as insulation.

g) This panel must be placed at least 20mm from the bottom of cooktop itself.

Important: When installing the hob above a built-in oven, the oven should be placed on two wooded strips; in the case of a joining cabinet surface, remember to leave a space of at least 45×560mm at the back.

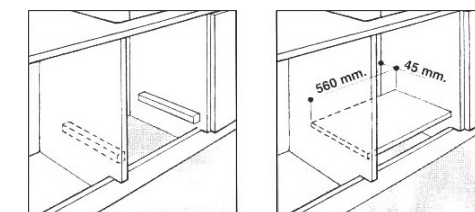

Gas connection for cooktop

The cooker should be connected to the gas-supply by a qualified installer. During installation of this product it is essential to fit an approved gas tap to isolate the supply from the appliance for the convenience of any subsequent removal or servicing. Connection of the appliance to the gas mains or liquid gas must be carried out according to the prescribed regulation in force, and only after it is ascertained that it is adaptable to the type of gas to be used. If connect to liquid gas, use pressure regulators that conform to the regulation in force.

Important: for safety, for the correct regulation of gas use and long life of the appliance, ensure that the gas pressure conforms to the indications given in table " product specifications "

Connection to non-flexible tube

(Copper or steel)

Connection to the gas source must be done in such a way as to not create any stress points at part of the appliance. The appliance is fitted with an adjustable, "L" shaped connector and a gasket for the attachment to the gas supply. Should this connector have to be turned, the gasket must be replaced (supplied with the appliance).

The feeding connector of the gas to the appliance is threaded G½ gas male cylinder

Connection to flexible steel tube

The gas feed connector to the appliance is a threaded, male G½ connector for round gas pipe and sealing gaskets that conform to the standards currently in force. The maximum length of the flexible pipes must not exceed 2000mm. Once the connection has been made, ensure that the flexible metal tube does not touch any moving parts and is not crushed.

Check the seal

Once the appliance has been installed make sure all the connections are properly sealed, using a soapy water solution. Never use a flame.

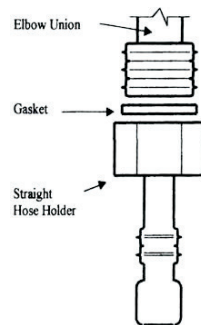

The placement of the burner

A. The placement of Triple Ring

1. Place the triple ring burner properly, and the spark plug must be aimed at the hole of the burner when install.
2. Put burner cap outer and burner cap inter ON burner properly.

B. The Placement method of Auxiliary Burner is same as above.

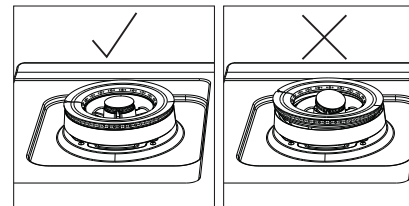

4.How to use your appliance

The position of the corresponding gas burner or electric hot plate(if present)is indicated near to each control knob.

Gas burners

The burner differ in size and power. Choose the most appropriate one for the diameter of the cookware being used.

The burner can be regulated with the corresponding control knob by using one of the following settings:

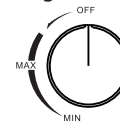

To light the selected burner ,first press the corresponding knob down fully, turn it anticlockwise to the max flame symbol and keep the knob pressed for approximately 2-3seconds to allow the safely device to heat up. The gas can be delivered when the valve is open.

To turn off a burner ,turn the knob clockwise until it stops (it should be on the "OFF"setting).

Caution: if the flame accidently goes out, turn off the gas with the control knob and wait at least 1minute before you try to light it again.

For best performance, follow these general guidelines:

- Use the appropriate cookware for each burner (see table)in order to prevent the flame from reaching the sides of the pot or pan;
- Always use cookware with a flat bottom and keep the lid on; When the contents come to a boil, turn the knob to "Min".

Burner	Φ cookware diameter(cm)
Big burner	26-28
Small burner	10-14

To identify the type of burner, refer to the designs in the section entitled" product Specifications".

Precautions for use

The following advice is intended to help you save energy and prevent cookware damage:



Use pans which are the right size for each burner. Do not use small receptacles on large burners. The flame should not touch the sides of receptacles.

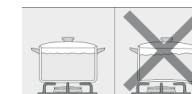

Do not use damaged cookware, which does not sit evenly on the hob. Pans may be over turned. Only use a pan with thick, flat base.

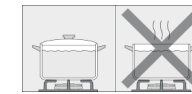

Do not cook without lids only partially covering receptacles. You are wasting energy.

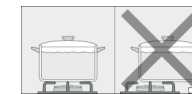

Always place the cookware right over the burner, not to one side. Otherwise it could be overturned. Do not place large pans on the burners near the controls. These may be damaged by the very high temperatures.



Place the pans on the pan supports, never directly on the burner. Pans should be placed on the hob carefully.

Make sure that the pan supports and burner cover are correctly positioned before using the appliance.